

Harman Kardon FL8550 Compact Disc Changer

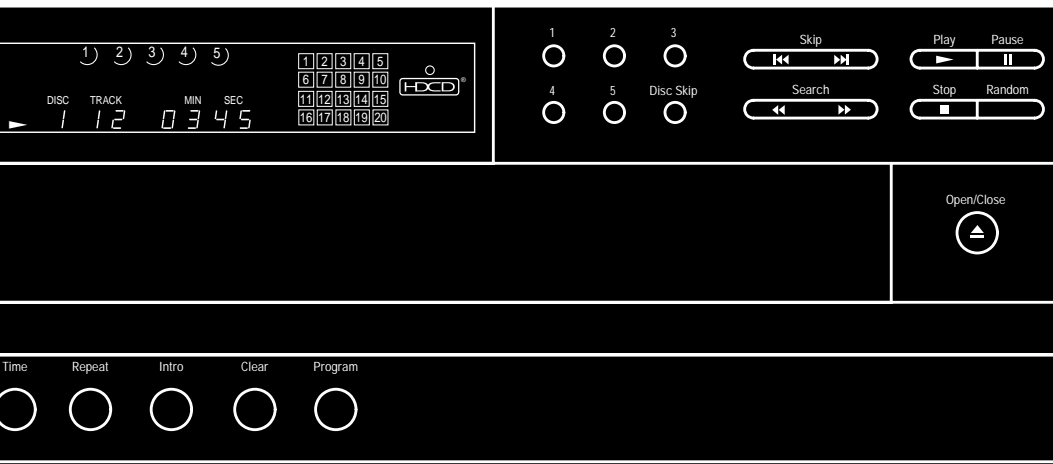

Owner's Manual

harman/kardon

Owner's Manual

FL8550 Compact Disc Changer

Table of Contents

Introduction	1
Safety Information	2-3
Unpacking.....	3
Front Panel Controls.....	4-5
Rear Panel Connections	6
Remote Control Functions	7-8
Installation	9
Operation	10-12
Loading Discs	10
Normal Play	11
HDCD®	11
Play Exchange	12
Time Display	12
Headphone Listening	12
Search Functions.....	13
Search	13
Skip	13
Intro Search	13
Programmed Play Operation.....	14-15
Programmed Play.....	14
Checking Program Contents.....	14
Clearing Programs	14
Repeat Play	15
Troubleshooting Guide	16
Technical Specifications	17

harman/kardon
250 Crossways Park Drive
Woodbury, NY 11797

H A Harman International Company
©1998 Harman Kardon, Incorporated

Introduction

1

Thank you for choosing the Harman Kardon FL8550 CD changer. The FL8550 is an exceptionally well-engineered product that offers high performance and ease of use.

We ask that you take a few minutes to read through this Owner's Manual to familiarize yourself with the controls and functions. This brief investment of time will yield dividends in the form of years of listening pleasure.

If you have any questions about this product, its installation or operation, please contact your dealer, as they are your best source of local information.

Description and Features

■ **Five-Disc CD Changer With Advanced Programming Features That Create Play Lists of Selected Tracks or Play Discs and Tracks in Random Order for Hours of Uninterrupted Play**

- **HDCD® Decoding Provides Superior Reproduction of All CDs, Whether HDCD Encoded or Not. When HDCD Encoded Discs Are Played, Special Circuitry is Used to Reveal Detail and Fidelity Not Possible in Ordinary CDs**
- **Digital Output for Direct Connection to Outboard Digital-to-Analog Converters**
- **Intro Search to Automatically Scan a Brief Portion of Each Track to Quickly Locate Your Favorite Selections**
- **Play Exchange Feature Allows Discs To Be Changed While Another Disc Is Playing**

Safety Information

2

Important Safety Information

Verify Line Voltage Before Use

Your FL8550 has been designed for use with 120-volt AC current. Connection to a line voltage other than that for which it is intended can create a safety and fire hazard, and may damage the unit.

If you have any questions about the voltage requirements for your specific model, or about the line voltage in your area, contact your selling dealer before plugging the unit into a wall outlet.

Do Not Use Extension Cords

We do not recommend that extension cords be used with this product. As with all electrical devices, do not run power cords under rugs or carpets or place heavy objects on them. Damaged power cords should be replaced immediately by an authorized service depot with cords meeting factory specifications.

Handle the AC Power Cord Gently

When disconnecting the power cord from an AC outlet, always pull the plug; never pull the cord. If you do not intend to use the unit for any considerable length of time, disconnect the plug from the AC outlet.

Do Not Open the Cabinet





There are no user-serviceable components inside this product. Opening the cabinet may present a shock hazard, and any modification to the product will void your guarantee. If water or any metal object such as a paper clip, wire or staple accidentally falls inside the unit, disconnect it from the AC power source immediately, and consult an authorized service station.

CAUTION: The FL8550 uses a Laser System. To prevent direct exposure to the laser beam, do not open the cabinet enclosure or defeat any of the safety mechanisms provided for your protection. **DO NOT STARE INTO THE LASER BEAM.** To ensure proper use of this product, please read this Owner's Manual carefully and retain it for future use. Should the unit require maintenance or repair, please contact your local Harman Kardon Service Station. Refer servicing to qualified personnel only.

Installation Location

■ To assure proper operation, and to avoid the potential for safety hazards, place the unit on a firm and level surface. When placing the unit on a shelf, be certain that the shelf and any mounting hardware can support the weight of the product.

- Make certain that proper space is provided both above and below the unit for ventilation. If this product will be installed in a cabinet or other enclosed area, make certain that there is sufficient air movement within the cabinet.
- Do not place the unit directly on a carpeted surface.
- Avoid installation in extremely hot or cold locations, or an area that is exposed to direct sunlight or heating equipment.
- Avoid moist or humid locations.

	CAUTION RISK OF ELECTRIC SHOCK DO NOT OPEN		
CAUTION: TO REDUCE THE RISK OF ELECTRIC SHOCK, DO NOT REMOVE COVER (OR BACK). NO USER-SERVICEABLE PARTS INSIDE. REFER SERVICING TO QUALIFIED SERVICE PERSONNEL.			
	The lightning flash with arrowhead symbol, within an equilateral triangle, is intended to alert the user to the presence of uninsulated "dangerous voltage" within the product's enclosure that may be of sufficient magnitude to constitute a risk of electric shock to persons.		The exclamation point within an equilateral triangle is intended to alert the user to the presence of important operating and maintenance (servicing) instructions in the literature accompanying the appliance.
WARNING: TO REDUCE THE RISK OF FIRE OR ELECTRIC SHOCK, DO NOT EXPOSE THIS APPLIANCE TO RAIN OR MOISTURE.			
CAUTION: TO PREVENT ELECTRIC SHOCK, MATCH WIDE BLADE OF PLUG TO WIDE SLOT, FULLY INSERT. ATTENTION: POUR EVITER LES CHOCS ELECTRIQUES, INTRODUIRE LA LAME LA PLUS LARGE DE LA FICHE DANS LA BORNE CORRESPONDANTE DE LA PRISE ET POUSSER JUSQU'AU FOND.			

Safety Information

Cleaning

When the unit gets dirty, wipe it with a clean, soft, dry cloth. If necessary, wipe it with a soft cloth dampened with mild soapy water, then a fresh cloth with clean water. Wipe dry immediately with a dry cloth. NEVER use benzene, aerosol cleaners, thinner, alcohol or any other volatile cleaning agent. Do not use abrasive cleaners, as they may damage the finish of metal parts. Avoid spraying insecticide near the unit.

Moving the Unit

Before moving the unit, be certain to disconnect any interconnection cords with other components, and make certain that you disconnect the unit from the AC outlet.

Important Information for the User

NOTE: This equipment has been tested and found to comply with the limits for a Class-B digital device, pursuant to Part 15 of the FCC Rules. The limits are designed to provide reasonable protection against harmful interference in a residential installation. This equipment generates, uses and can radiate radio-frequency energy and, if not installed and used in accordance with the instructions, may cause harmful interference to radio communication. However, there is no guarantee that harmful interference will not occur in a particular installation. If this equipment does cause harmful interference to radio or television reception, which can be determined by turning the equipment off and on, the user is encouraged to try to correct the interference by one or more of the following measures:

- Reorient or relocate the receiving antenna.
- Increase the separation between the equipment and receiver.
- Connect the equipment into an outlet on a circuit different from that to which the receiver is connected.
- Consult the dealer or an experienced radio/TV technician for help.

This device complies with Part 15 of the FCC Rules. Operation is subject to the following two conditions: (1) this device may not cause harmful interference, and (2) this device must accept interference received, including interference that may cause undesired operation.

NOTE: Changes or modifications may cause this unit to fail to comply with Part 15 of the FCC Rules and may void the user's authority to operate the equipment.

Unpacking

The carton and shipping materials used to protect your new receiver during shipment were specially designed to cushion it from shock and vibration. We suggest that you save the carton and packing materials for use in shipping if you move, or should the unit ever need repair.

To minimize the size of the carton in storage, you may wish to flatten it. This is done by carefully slitting the tape seams on the bottom and collapsing the carton down to a more two-dimensional appearance. Other cardboard inserts may be stored in the same manner. Packing materials that cannot be collapsed should be saved along with the carton in a plastic bag.

If you do not wish to save the packaging materials, please note that the carton and other sections of the shipping protection are recyclable. Please respect the environment and discard those materials at a local recycling center.

Typographic Conventions

In order to help you use this manual with the remote control, front panel controls, rear panel connections and front panel displays, certain conventions have been used.

Example – (bold type) indicates a specific remote control or front panel button, or rear panel connection jack

EXAMPLE – (OCR type) indicates a message that is visible on the front panel information display

EXAMPLE – (bold type) indicates a lit indicator in the front panel information display

1 – (number in a square) indicates a specific front panel control

1 – (number in an oval) indicates a button or indicator on the remote

1 – (number in a circle) indicates a rear panel connection

Front Panel Controls

4

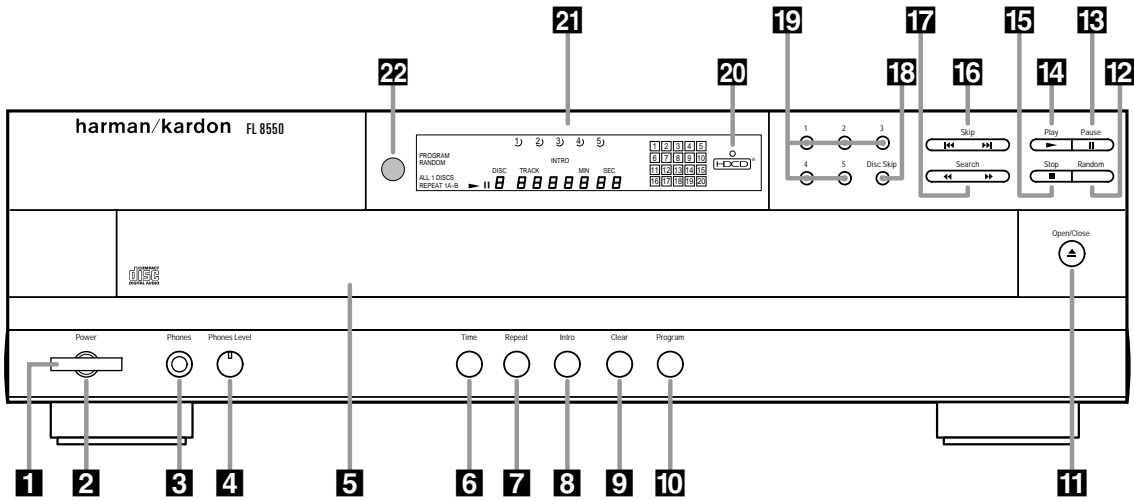

- 1** Power Switch
- 2** Status Mode Indicator
- 3** Headphones Jack
- 4** Headphones Level Control
- 5** CD Drawer
- 6** Time Button
- 7** Repeat Button
- 8** Intro Button

- 9** Clear Button
- 10** Program Button
- 11** Open/Close Button
- 12** Random Button
- 13** Pause Button
- 14** Play Button
- 15** Stop Button
- 16** Skip Button

- 17** Search Button
- 18** Disc Skip Button
- 19** Disc Select Buttons
- 20** HDCD Indicator
- 21** Information Display
- 22** Remote Sensor

Front Panel Controls

5

1 Power Switch: Press this switch to apply power to the FL8550. When the FL8550 is first connected to AC power, the **Status Mode Indicator 2** will turn green, and the **Information Display 21** will illuminate. Press the switch again to turn the unit off, and the **Status Mode Indicator** will turn amber, indicating that the unit is in a Standby mode. When the FL8550 is connected to a switched AC outlet, such as those found on the back of many audio products, it will return to the ON mode when power is applied to the switched outlet without any further press of the switch.

2 Status Mode Indicator: When the FL8550 is in the ON mode, this indicator will glow green. When the unit is off, the indicator will glow amber, indicating that the unit is still connected to the AC mains supply.

3 Headphones Jack: Connect a set of standard headphones to this jack for private listening.

4 Headphones Level Control: Turn this knob to increase or decrease the volume level for headphones connected to the FL8550's **Headphones Jack 3**. Note that changing this level will not change the sound level for the unit's main output, as that remains constant.

5 CD Drawer: This drawer holds the discs that will be played. Press the **Open/Close button 11 1** to open the drawer so that discs may be inserted.

6 Time Button: Press this button to select the time display. In normal operation, the display will show the running time of the track being played. Press the button once to check the time remaining for the track in play. Press the button a third time to view the total play time remaining for the disc in play.

7 Repeat Button: Press this button once to constantly repeat the track currently being played. Press it a second time to repeat the entire disc. (See page 15 for more information.)

8 Intro Button: Press this button to put the FL8550 in the Intro Scan mode. When you press the button, the unit will play the first 10 seconds of each track on the disc, and then move to the next track. Press the button again to defeat the function and continue full play of the current track. (See page 13 for more information.)

9 Clear Button: Press this button to remove tracks from a programmed sequence. Each press of the button will remove one track, starting with the last track programmed to play. (See page 14 for complete information on programming the FL8550.)

10 Program Button: This button is used to program the playback of a disc in a particular order. (See page 14 for complete instructions on programming the FL8550.)

11 Open/Close Button: Press this button to open or close the disc drawer. DO NOT push the drawer to close it, or damage to the transport mechanism may result.

12 Random Button: Press this button to put a disc into play, and to have all of the tracks played in a random order. (See page 11 for more information.)

13 Pause Button: Press this button once to momentarily pause a disc. When the button is pressed again, the disc will resume play at the point it was paused.

14 Play Button: Press this button to start the playback of a CD. If the CD drawer is open, pressing this button will automatically close the drawer.

15 Stop Button: Press this button to stop the disc currently being played. (See page 11 for more information.)

16 Skip Button: Press either side of this button to move to the next track **▶▶**, or to move back to the previous track **◀◀** on the disc being played.

17 Search Button: Press either side of this button to search forward **▶▶▶** or backwards **◀◀◀** through a disc to locate a particular portion of the selection of the disc being played.

18 Disc Skip Button: Press this button to change to the next disc. If a disc position is empty, the FL8550 will automatically search for the next position that contains a disc.

19 Disc Select Buttons: Press one of these buttons to select the disc in a specific position in the CD drawer.

20 HDCD Indicator: This LED will light automatically when a CD with HDCD encoding is playing. No further action is needed to enjoy the benefits of HDCD.

21 Information Display: This display provides details about the operation of the FL8550.

22 Remote Sensor: The sensor behind this window receives commands from the remote control. Keep this area clear if you wish to use the FL8550 with a remote control.

Rear Panel Connections

6

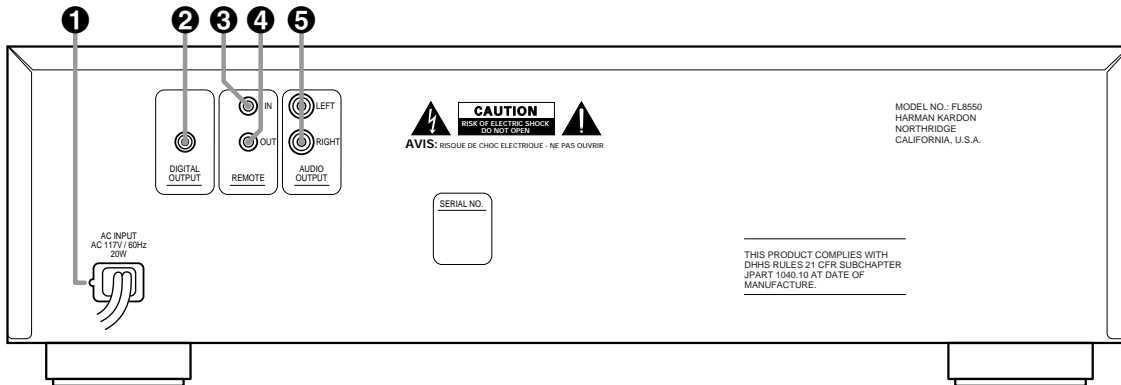

- ① AC Power Cord
- ② Coaxial Digital Output

- ③ Remote Control Input
- ④ Remote Control Output

- ⑤ Fixed Audio Outputs

① AC Power Cord: Connect this plug to an AC outlet. If the outlet is switch controlled, make certain that the switch is in the ON position.

② Coaxial Digital Output: Connect this jack to the coaxial digital input of an external digital-to-analog converter for direct access to the digital signals of the FL8550. DO NOT connect this jack to the standard audio inputs of any device.

③ Remote Control Input: Connect the output of a remote infrared sensor or the remote control output of another compatible Harman Kardon product. This will enable the remote control system to operate even when the front panel **Remote Sensor 22** is blocked. It will also allow use of the FL8550 with optional, external control systems.

④ Remote Control Output: Connect this jack to the input of another compatible Harman Kardon remote controlled device to have the remote sensor on the FL8550 provide signals to other products.

⑤ Fixed Audio Outputs: Connect these jacks to the CD audio inputs of your receiver, surround processor or preamplifier.

Remote Control Functions

7

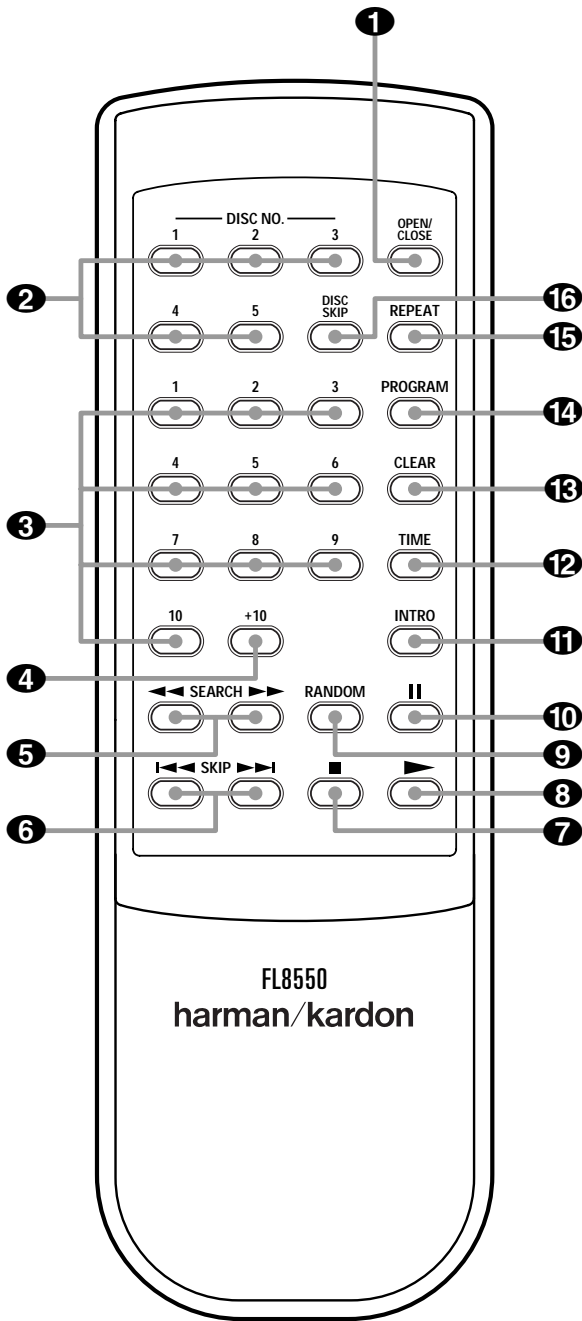

- 1 Open/Close Button
- 2 Disc Select Buttons
- 3 Numeric Buttons
- 4 +10 Button
- 5 Search Buttons
- 6 Skip Buttons
- 7 Stop Button
- 8 Play Button
- 9 Random Button
- 10 Pause Button
- 11 Intro Button
- 12 Time Button
- 13 Clear Button
- 14 Program Button
- 15 Repeat Button
- 16 Disc Skip Button
- 17 Battery Compartment

Remote Control Functions

8

1 Open/Close Button: Press this button to open or close the disc drawer. The drawer may also be closed by pressing the **Play** button **14** **8**. Do not push the drawer, as damage to the transport mechanism may result.

2 Disc Select Buttons: Press one of these buttons to select the disc in a specific position in the CD drawer.

3 Numeric Buttons: Press these buttons to select a specific track on a disc. The FL8550 will immediately go to the track and begin to play it. For tracks 1 through 10 on a disc, you need only press the desired number. For tracks 10 and above, press the **+10** button **4** to select the first digit of the track number, and then press the second digit from these numeric buttons. These buttons are also used to enter track numbers into the memory for pre-programmed play lists. (See page 14 for complete information on programming the FL8550.)

4 +10 Button: Press this button to select the first digit of a track number above 10. Each press of the button increases the first digit one increment. Press it once to start accessing tracks 10 through 19, twice to start accessing tracks 20 through 29, and so forth. For example, to select track 22, press the **+10** button twice, and then press the **2** button **3**.

5 Search Buttons: Press these buttons to search forward **▶▶** or backwards **◀◀** through a disc to locate a particular portion of the selection being played.

6 Skip Buttons: Press one of these buttons to move to the next track **▶▶**, or to move back to the previous track **◀◀** on the disc being played.

7 Stop Button: Press this button to stop the disc currently being played.

8 Play Button: Press this button to start the playback of a CD. If the CD drawer is open, pressing this button will automatically close the drawer.

9 Random Button: Press this button to put a disc into play, and to have all of the tracks played in a random order. (See page 11 for more information.)

10 Pause Button: Press this button once to momentarily pause a disc. When the button is pressed again, the disc will resume play at the point it was paused.

11 Intro Button: Press this button to put the FL8550 into the Intro Scan mode. When you press this button, the unit will play the first 15 seconds of each track on the disc, and then move to the next track. Press the button again to defeat the function and continue full play of the current track. (See page 13 for more information.)

12 Time Button: In normal operation, the display will show the running time of the track being played. Press the button once to check the time remaining for the track in play. Press the button again to view the total play time remaining for the disc in play.

13 Clear Button: Press this button to remove tracks from a programmed sequence. Each press of the button will remove one track, starting with the last track programmed to play. (See page 13 for complete information on programming the FL8550.)

14 Program Button: This button is used to program the playback of a disc in a particular order. (See page 14 for complete instructions on programming the FL8550.)

15 Repeat Button: Press this button once to constantly repeat the track currently being played. Press it a second time to repeat the entire disc. (See page 15 for more information.)

16 Disc Skip Button: Press this button to change to the next disc. If a disc position is empty, the FL8550 will automatically search for the next position that contains a disc.

Installation

9

To prevent possible damage to your speakers and other components in your audio system, it is important that ALL components, including the FL8550 and receivers are turned off and unplugged from their AC power source when installing any new component.

Connecting the FL8550 to your audio system is simple. Using standard RCA-to-RCA interconnect cords, connect the left and right **Fixed Audio Output** jacks ⑤ on the rear panel to the CD input jacks on your receiver, surround processor or preamplifier.

If your system includes an optional, external digital-to-analog converter, or if you are using a receiver or other processor that has the capability to decode PCM digital input signals, connect the **Coaxial Digital Output** jack ② to the Datastream Digital input on the decoder. Make certain to use a coaxial-style interconnect cable, as standard audio cables will not perform as well.

Install the two AA batteries supplied with the FL8550's remote by turning the remote over so that you are holding the bottom side up. Press lightly on the embossed arrow on the cover, and gently slide the cover towards you in the direction of the arrow. Insert the batteries inside the compartment, being careful to follow the + and - polarity indications at the bottom of the compartment. Replace the cover by placing it on the remote and sliding it back towards the top of the remote.

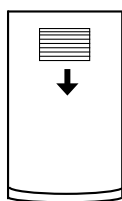
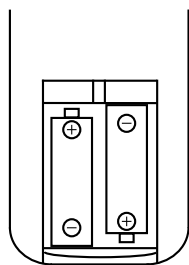
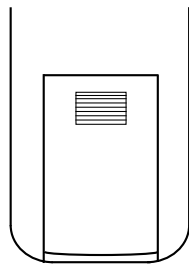

NOTE: When replacing batteries it is always a good idea to replace both at the same time. When the unit will not be used for an extended period of time, it is also a good idea to remove the batteries so that the potential for corrosion or damage is avoided.

Connect the power to a non-switched AC wall outlet, or to the accessory outlet on the rear of another audio device in your system and you are ready to go!

NOTE: When using the accessory outlet on another product to power the FL8550 make certain that it has the ability to power a device that draws at least 20 watts of current in addition to the requirements of other devices that may be plugged into the accessory outlets. If you use a "switched" outlet, it is important to remember that the host product must be turned on in order for the FL8550 to operate.

Operation

10

Loading Discs

To load a disc, first turn the FL8550 on using the **Power Switch 1**. Note that the **Status Mode Indicator 2** will turn green and the **Information Display 21** will illuminate. The word `disc` will flash in the Information Display, and the disc tray will automatically turn clockwise so that the FL8550 can sense which, if any, of the disc positions already have a disc.

To load a disc, first press the **Open/Close button 11 1**, taking care to make certain that the space in front of the drawer is not obstructed. Note that if the drawer is blocked when attempting to open it, it will automatically close within five seconds to protect the mechanism.

Load discs in the tray with the printed (label) side facing up towards you. Make certain that the disc is centered in the tray. Either 5" (12cm) or 3" (8cm) discs may be used. When a 3" (8cm) disc is played, it should be carefully centered within the smaller ridges on the tray. Only one CD may be placed in any position at a time. When a 3" (8cm) is played, DO NOT place a standard 5" (12cm) disc over the smaller disc.

Labeled surface

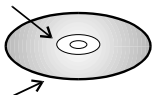

Recorded surface

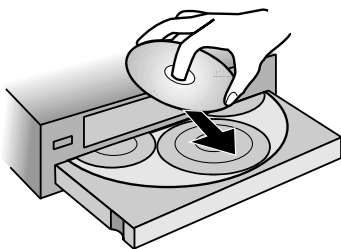

Note that each disc position has a number embossed in the plastic tray. This corresponds to the position this disc will occupy for playback and programming. To make it easier to identify each disc's position, the disc position number for the holder space that is in the center of the disc tray will also appear in the Information Display when the disc drawer is open.

To rotate the disc tray to another position, press the **Disc Skip button 18 16**. The tray will revolve clockwise to the next slot, and the Information Display will indicate the position number for the slot in the middle of the tray.

To close the disc drawer, press the **Open/Close button 11 1**. When the drawer closes, the disc that was last in the center position on the tray will be readied for play. Its number will appear in the Information Display, and a flashing red line will surround the icon for that disc. The icons for all other tray positions that have a disc will be surrounded with a blue line. If the center disc position is empty when the drawer is closed, the unit will search for the next position with a disc loaded, and place that spot in the ready mode.

The drawer may also be closed and the FL8550 put into play by pressing the **Play button 14 8**. This will put the disc in the center position into the Play mode. To close the drawer and play a specific disc, press the **Disc Select button 19 2** corresponding to the tray position number for the disc you wish to play.

When the disc drawer closes, the Information Display will briefly display the disc number, the total number of tracks on the disc and the disc's total

running time. After five seconds, the display will indicate the disc number that is in the play position, both by a flashing red line surrounding the disc's icon and the wording in the display, such as `disc 5`. The total number of tracks on the disc will illuminate at the far right side of the display.

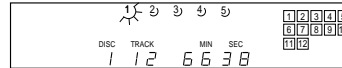

To remove a disc from the player, press the **Open/Close button 11 1**. The drawer will open, allowing the discs to be removed. Press the **Disc Skip button 18 16** to rotate the disc carousel tray to reach discs that may be covered. When a disc does not occupy a numbered tray, *and the sensor detects no disc present*, the disc number will drop from the display.

Upon placing a disc in the unoccupied tray, the disc number will reappear *when detected by the sensor mechanism*.

Disc-Handling Notes

When loading or unloading discs, it is best to hold them by the edges.

While Compact Discs are very reliable, rough handling may damage them. Avoid scratching the bottom (non-printed) side of discs, or any handling that will leave fingerprints.

To avoid damage to the disc and player, always seat discs so that they are centered in the tray.

Do not lift the player while the disc tray is opening or closing, as this may cause the discs to unseat from the tray and possibly jam.

Operation

11

Normal Play

Once the discs have been loaded, they may be played in a number of different ways.

To play all of the tracks on each disc in order, starting with the first track on the disc currently in the play position, and proceeding through each disc that has been loaded, press the **Play** button **14** **8**.

To start play on a specific disc, press the **Disc Select** button **19** **2** that corresponds to the desired disc's position in the disc tray. If no disc is found in the selected position, the unit will search for the next disc.

To play the discs in the FL8550 in random order while in the Play mode, press the **Random** button **12** **9**. When the discs are at a stop, press the **Random** button **12** **9** and then the **Play** button **14** **8**. The indicator will light and the FL8550 will select a disc from those loaded, and then select a track to play. At the conclusion of the first track selection, another track will be selected. Playback will continue with each disc and track being randomly chosen by the FL8550's microprocessor until all tracks on all discs have been played.

When a disc is in play, the Information Display will show a play indication **▶**, and the icon for the disc position in use will flash. The track being played will show both as a large number in the middle of the display and as a smaller, flashing number at the right side of the display. The elapsed time of the track being played will appear in the display. As the disc plays, the track numbers will change, and the time will reset to **□ □ : □ □** at the start of each new track. To momentarily pause the play of a disc, press the **Pause** button **13** **10**. Note that a Pause indication **||** will appear in the display to remind you that the disc is paused. Press either the **Play** button **14** **8** or the **Pause** button **13** **10** to resume to normal play.

You may also directly select a specific track on the disc being played directly by entering the track number via the **Numeric Controls** **3** **4**. To play tracks one through ten, simply press the button **3** corresponding to the desired track. To select a track number above 10, first press the **+10** button **4** until the digit of the track number is shown in the display. For example, press the button once for tracks 11 through 19, twice for 20 through 29, and so forth. Once the first digit of the track number is selected, press the **Numeric** button **3** corresponding to the second digit within five seconds. The unit will pause briefly to find the track and then go into the play mode.

To stop the disc, press the **Stop** button **15** **7**. When the stop button is pressed the display will again show the total number of tracks and total running time of the last disc to be played.

HDCD

HDCD, which stands for High Definition Compatible Digital®, is a sophisticated process that enables the FL8550 to deliver outstanding digital-to-analog decoding no matter what type of CD is played.

When a disc with the HDCD logo is played, the FL8550 is able to take advantage of the special recording process that is used in the creation of HDCD discs. Although HDCD discs are playable on any CD player, when they are played on a unit such as the FL8550, the special circuitry enables audio with extraordinary fidelity, stunning resolution and the highest possible overall quality. The HDCD process effectively cancels the additive and subtractive distortions that are present in other recordings.

No special adjustment is required to play an HDCD disc. Simply play the disc as you would with any other CD, and the FL8550 will automatically sense that it is an HDCD recording. An indicator will illuminate on the front panel to remind you that an HDCD disc is playing.

It is important to note that the HDCD process is completely compatible with standard recordings. Indeed, the high-quality digital-to-analog circuitry that is part of HDCD enables you to enjoy many of the benefits of HDCD-encoded discs.

Operation

12

Play Exchange

The FL8550's Play Exchange feature allows you to change discs while the machine is playing. Using this feature, you can have uninterrupted play of an unlimited number of discs, since the drawer may be opened and discs changed while the machine is still in play.

To use the Play Exchange function, simply press the **Open/Close** button **11** **1** at any time while the unit is in the Play mode. The disc drawer will open and two discs will be available for change. Replace either disc, or both, as desired. To reach the other two discs, press the **Disc Skip** button **13** **16**. You may now remove and change either of these two discs.

When you have finished making any disc changes, press the **Open/Close** button **11** **1**. The drawer will close and play will continue with normal functions.

Time Display

The FL8550's time display is capable of showing a wide range of information about a CD.

In normal operation the display will show the total running time of the CD that is currently being played. Each time the track changes, the time display will reset to $\square\square:\square\square$ and begin to increase again as the disc plays.

To view the time remaining on an individual track, press the **Time** button **6** **12** once. The display will now show the time left in the track currently playing.

To view the total time remaining to play on the disc, press the **Time** button **6** **12** twice. In this time display mode the **TRACK** indication will show the tracks remaining, not the usual display of the track being played.

Headphone Listening

You may listen to the output of the FL8550 through headphones by plugging a set of standard headphones with a $\frac{1}{4}$ " headphone plug into the front panel **Headphones Jack** **3**. The volume of the headphone output may be adjusted with the **Headphones Level Control** **4**. Note that changing the headphone level will not change the volume for the main audio output. This is a fixed output, and it is changed using the volume control on your receiver, preamplifier or surround processor.

Search Functions

13

The FL8550 is equipped with a variety of functions that make it easy to search for specific parts of any CD.

Search

If you wish to quickly scan through a disc to locate a particular passage or program, press the **Search** buttons **17** **6**. The **Forward Search** button **▶▶** plays the disc forward in high speed, while the **Reverse Search** button **◀◀** plays the disc backwards in high speed. When the desired part of the disc is heard, release the **Search** button to resume normal play speed.

Skip

To move from one track on a disc to another, press one of the **Skip** buttons **16** **6**. Pressing the **Forward Skip** button **▶▶** will move you forwards through the disc, one track at a time, while pressing the **Reverse Skip** button **◀◀** will move you back one track at a time.

The Skip buttons may be used when the FL8550 is either playing or stopped. If the unit is stopped, the Skip buttons may be used to locate the first track to be played. The **Play** button **14** **8** must be pressed to begin play. If the Skip buttons are used while the unit is already playing, the audio output will stop while the new track is located, and play will automatically resume after the Skip button is released.

Intro Search

This feature lets you locate a track by playing the first 10 seconds of each track. When the **Intro** button **8** **11** is pressed, the unit will play only 10 seconds of each track, and then automatically move to the next track. When you have reached a track that you wish to listen to in its entirety, press the Intro button again to resume normal operation. When the Intro feature is activated, the **INTRO** indicator will illuminate in the **Information Display** **21** to remind you that Intro Search is in use.

When the Intro button is pressed, the FL8550 will first play through the disc that is currently in the play position, and then move on to each disc position that is loaded.

Programmed Play Operation

14

The FL8550's advanced programming capability enables you to preset the order in which tracks play, repeat specific discs or tracks, repeat all discs and tracks, and/or repeat any portion of a specific disc.

Programmed Play

Programmed play allows you to program up to 32 tracks or complete-disc play-through into the FL8550's memory. To begin programming the FL8550, press the **Program** button **10** **14**, followed by the **Play** button **14** **8**. The **PROGRAM** indicator will light in the **Information Display** **21**.

You may now begin to enter the discs and tracks in the order in which you wish to have them play. Once the **PROGRAM** indicator is lit, **P-01** will appear in the **Information Display**, replacing the track time. This indicates that you are about to program the first track.

Press the **Disc Select** button **19** **2** to choose the first disc to be programmed, and note that **ALL** will flash in the **Information Display**. To have all tracks on the disc play in order as the first program step, press the **Program** button **10** **14**. To select a single track on the disc, press the **Numeric** buttons **3** corresponding to the desired track. You may also use the **Skip** buttons **16** **6** to select a track.

When the disc and track are selected, press the **Program** button **10** **14**. Note that the program step indication on the right side of the **Information Display** will change to **P-02**. You may now select another disc and/or track for the next program step following the instruction shown above. When the program step is selected, press the **Program** button **10** **14**. Repeat this procedure for each program step until you have completed the desired programming. Press the **Stop** button **15** **7** to complete a program sequence, or press **Play** **14** **8** to begin immediate play of a program sequence. If the maximum of 32 program steps is reached, the program step indication at the right side of the **Information Display** will go out, and the disc and track that have been programmed as the first program step will be shown.

Once a program list has been played, press the **Play** button **14** **8** to begin listening to the sequence. After the entire program has been played, the FL8550 will stop. As long as the **Stop** button **15** **7** has not been pressed, and the **PROGRAM** indicator remains lit, you may repeat the programmed play sequence again by pressing the **Play** button **14** **8**.

Pressing the **Stop** button **15** **7**, opening the disc drawer by pressing the **Open/Close** button **11** **1** or turning the FL8550 off will erase the program information from the unit's memory.

Checking Program Contents

To check the contents of a program while the unit is stopped, press the **Skip** buttons **16** **6** and the **Information Display** will step through each of the programmed discs and tracks.

Clearing Programs

When the unit is stopped, but the **PROGRAM** indicator is still lit, you may clear the entire contents of a program by pressing the **Clear** button **9** **13**.

Programmed Play Operation

15

Repeat Play

The FL8550's programming system enables you to repeat either all of the tracks on all of the discs, a complete single disc or a single track.

Repeat Track Play

To repeat a single track, press the **Repeat** button **7 15** while the desired track is playing so that the **REPEAT 1** indicator is lit. The desired track may also be selected using the **Disc Select** buttons **19 2** and then the **Skip** buttons **16 6**. When the track is chosen, press the **Repeat** button **7 15** and the **Play** button **14 8**. The track will play until the **Stop** button **15 7** is pressed.

Repeat Disc Play

To repeat an entire disc, press the **Repeat** button **7 15** twice so that the **REPEAT 1 DISC** indicator is lit. Press the **Disc Select** buttons **19 2** until the desired disc's icon is surrounded by a red line and the disc number appears in the Information Display. The selected disc will play through to the end, and then continue to repeat until the **Stop** button **15 7** is pressed.

Repeat All Discs

To repeat all of the discs that have been loaded into the FL8550, press the **Repeat** button **7 15** three times so that the **REPEAT ALL DISCS** indicators are lit.

Press the **Play** button **14 8**, and the unit will play all tracks on all discs, starting with the disc that has been loaded in the play position. When all discs have played through, the sequence will repeat and the discs will continue to play until the **Stop** button **15 7** is pressed.

NOTE: You may cancel a repeat function any time by pressing the **Repeat** button **7 15** until the **REPEAT** indicators go out. The player will continue with normal play and then stop when the current disc is finished playing.

Troubleshooting Guide

16

Troubleshooting Guide

<i>SYMPTOM</i>	<i>CAUSE</i>	<i>SOLUTION</i>
No lights on front panel	<ul style="list-style-type: none">• No AC power	<ul style="list-style-type: none">• Make certain that the AC power cord is plugged into a live outlet.
Remote does not appear to operate	<ul style="list-style-type: none">• Main Power Switch turned off• Weak batteries• Blocked sensor	<ul style="list-style-type: none">• Turn on Main Power Switch.• Install fresh batteries, observing polarity indications.• Remove obstructions from the front panel sensor or connect a remote sensor to the Remote In jack on the rear panel.
Front panel lights, but CD does not play	<ul style="list-style-type: none">• Disc upside down• Moisture inside unit	<ul style="list-style-type: none">• Reload disc with label side facing up.• Leave the unit turned ON for 30 minutes to allow moisture to evaporate.
Play indicator lights, but no sound is heard	<ul style="list-style-type: none">• Poor connections• Wrong source selected	<ul style="list-style-type: none">• Make certain connections are secure and made to the correct (e.g., CD) input.• Select CD source on receiver or preamp.
Sound skips or stutters during play	<ul style="list-style-type: none">• Disc may be damaged• Surface vibrations	<ul style="list-style-type: none">• Try another disc.• Isolate the unit from vibration by placing it on a firm surface or move it further away from speakers.
Sound is continually distorted	<ul style="list-style-type: none">• Incorrect input	<ul style="list-style-type: none">• Make certain that the FL8550 is connected to a line-level audio input, NOT a digital audio or phono input.

Technical Specifications

17

Signal Format

Sampling Frequency	44.1kHz
HDCD Processing	PMD-100 (Pacific Microsonics)
D/A Conversion	Dual 20 Bit (Burr Brown PCM1702 x 2)
Oversampling	8 times

Discrete Analog Output Section

Error Correction	CIRC System
Frequency Response	20Hz – 20kHz +0, –0.5dB
Total Harmonic Distortion (THD)	<0.01% @ 1kHz
Dynamic Range	>100dB
Signal-to-Noise Ratio	>105dB
Channel Separation	80dB
Line-Output Level	2.0V RMS
Digital Output	Coax

General

Power Requirement	120V/60Hz
Power Consumption	20 Watts
Dimensions	
Width	17.3" (440 mm)
Height	5.1" (129 mm)
Depth	15.2" (386 mm)
Weight	16.7 lbs (7.6 kg)

Depth measurement includes knobs and buttons.

Height measurement includes feet and chassis.

All features and specifications are subject to change without notice.

HDCD and High Definition Compatible Digital are registered trademarks of Pacific Microsonics, Inc.

